

ST-5S-BT2 - Smart Tweezers™ with Bluetooth

ST-5S-BT2 features a Bluetooth™ Low-Energy link to mobile platforms. The link allows for visualization of measurements and measurement parameters, recording measurement sets, configuration of data boundaries and value alerts.

MAIN FEATURES and BENEFITS

- » Bluetooth™ Connectivity
- » Convenient one-hand operation
- » Ideal for Surface Mount Devices
- » Built-in high-precision LCR probe
- » Automated component identification
- » Automated test range selection
- » Manual C, R, L, Z and ESR modes
- » Test signal levels 0.25-1.0 Vrms
- » Swiss-made precise test leads
- » Diode Polarity/Short Testing
- » Secondary D, Q, ESR parameters
- » Portable and ergonomic design
- » Built-in Li-Ion battery
- » Universal Micro USB charger
- » High visibility OLED display

**AVAILABLE ONLY FOR
iOS and ANDROID**



TESTING SURFACE MOUNT DEVICES

Surface mount devices are usually tiny and without wire leads, making it more difficult to test and identify SMD than conventional components. Smart Tweezers™ gives users an easy way to sort and evaluate loose components and to perform on-board measurements and debugging.

Ideal-tek precise leads produced reliably contact even the smallest SMD components and take measurements from already mounted devices. The probe can also be used to test conventional components with wire leads too short to insert into the test terminals.

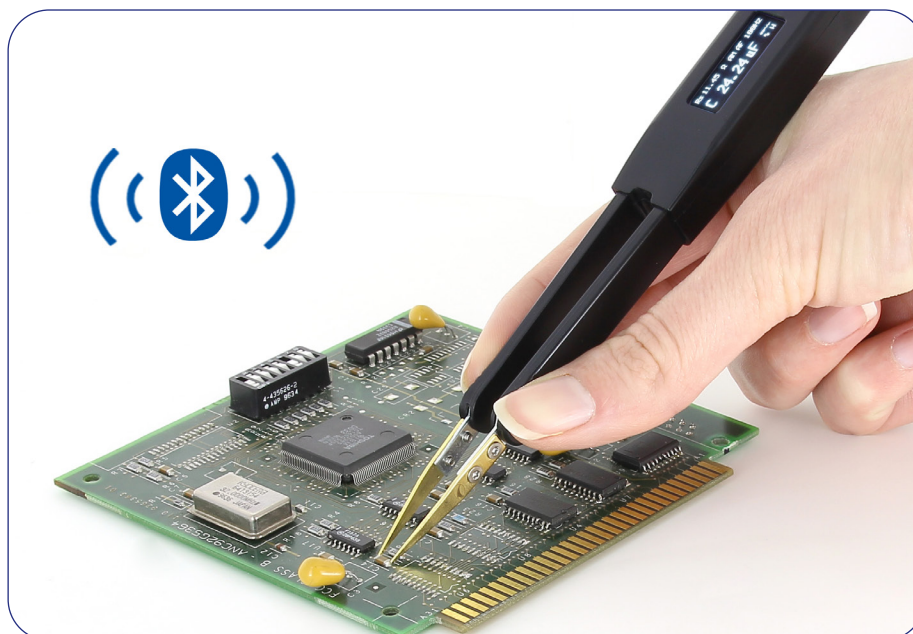

AUTOMATED MEASUREMENTS

Take measurements faster with Smart Tweezers™ using the automatic component identification function eliminating unnecessary trial and error time.

Smart Tweezers™ automatically specifies L, C, or R with parallel and series mode and selects a proper measurement range and test frequency for high accuracy measurements. The unit displays component type and more detailed component analysis such as Z and ESR.

TECHNICAL SPECIFICATIONS

AC test mode Test frequency:	1 kHz, 10 kHz, 120 Hz, 100 Hz
Test frequency accuracy:	50 PPM (0.005%)
Test signal level:	0.41/0.91 +/- 10% Vrms Sine wave
Source impedance:	100Ω +/- 1%

MEASUREMENT RANGES

Resistance R:	0.05 Ω to 9.9 MΩ
Capacitance C:	0.5 pF to 4999 μF
Inductance L:	0.5 uH to 999 mH
Quality factor Q:	0.001 to 1000
Dissipation factor D:	0.001 to 1000

PHYSICAL SPECIFICATIONS

Operating temperature:	0°C to 50°C
Battery Type:	3.7V LiPO rechargeable 180mAh
Battery Life (continuous):	20 hours, 3 hours charging cycle
Weight:	29 grams (0.06 lb)
Size:	15.0x1.8x1.5 cm (5.9 x 0.7 x 0.6 in)

WIDE SPECTRUM OF ADDITIONAL FUNCTIONS

- » Smart Tweezers™ LCR meter allows you to test various component types, including secondary components of Dissipation Factor (D), Quality Factor (Q). This handheld also includes other functions that result in a more detailed component analysis.
- » The built-in Equivalent Series Resistance (ESR) mode helps you better understand the inherent resistance - behavior typically found in capacitors across selected frequencies.
- » In its DIODE mode Smart Tweezers™ tests diode polarity and indicates if it is short.
- » Smart Tweezers™ has a continuity detector. Variable beeper sounds for resistance reading below set thresholds. Additionally, this function helps to locate shorted conductors (e.g. on a PCB).
- » In manual modes Smart Tweezers™ measures a specific circuit parameter — L, C, R, Z or ESR. Manual modes also improves component type identification for in-circuit tests.

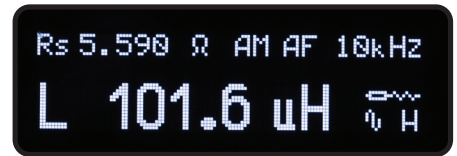

Smart Tweezers™ greatly simplifies testing and troubleshooting process.

Resistance, capacitance and inductance can be measured with automatic selection of the test parameters and range.

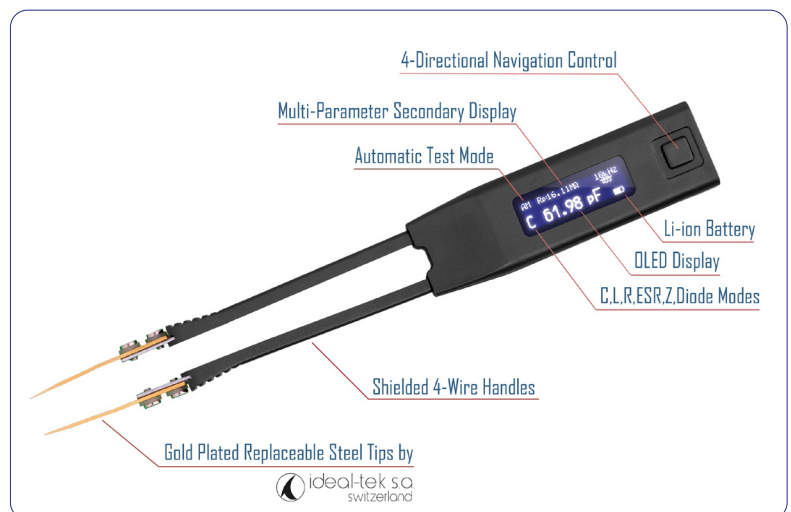

- » Variable test signal output from 0.41 to 0.91 Vrms allows to improve test precision in different situation e.g. for in-circuit measurement and loose leaded ceramic capacitors.
- » Visible and audible tolerance mode allows to perform component sorting.
- » Math null function allows to store a pre-measured offset and improve measurement precision.

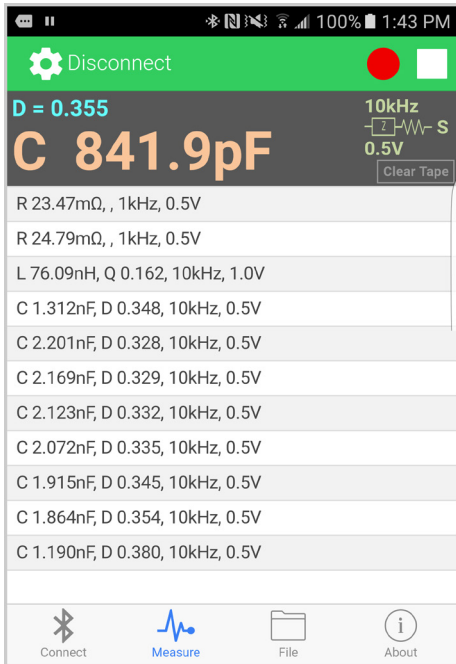

Apple iOS and Google Android apps offer portable connection and data recording solutions.

APPLE IOS AND GOOGLE ANDROID APPS

Smart Tweezers Bluetooth Companion iOS and Android apps enable ST-5S-BT2 connection to mobile devices and tablets direct without additional receivers.

The apps reflect measurement streams and offer CSV data file recording, recorded CSV stream management as well as extensive data sharing capabilities.

TURN BLUETOOTH ON AND OFF

- » Enter the menu interface
- » Select SYSTEM

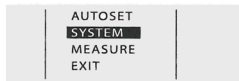

- » Scroll down to BLUETOOTH, select

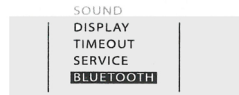

- » Select ON to turn on Bluetooth



- » Select OFF to turn it off
- » Select RESTART to reconnect

DISPLAY ELEMENTS

- » Bluetooth enabled

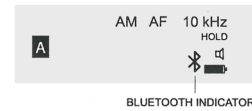

»

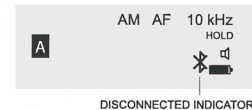

MOBILE APPS

Go to your app mobile store and search for “**Smart Tweezers LCR Bluetooth**” in the search box and you will see the app as the first result in the search.



**AVAILABLE ONLY FOR
iOS and ANDROID**

ACCURACY SPECIFICATIONS

RESISTANCE, IMPEDANCE

RANGE	RESOLUTION	100 Hz	1 kHz	10kHz
1 Ω	0.001 Ω	0.7% + 50	0.7% + 50	0.7% + 50
10 Ω	0.01 Ω	0.7% + 8	0.7% + 8	0.7% + 8
100 Ω	0.01 Ω	0.2% + 3	0.2% + 3	0.2% + 3
1000 Ω	0.1 Ω	0.2% + 3	0.2% + 3	0.2% + 3
10 kΩ	0.001 kΩ	0.2% + 3	0.2% + 3	0.2% + 3
100 kΩ	0.01 kΩ	0.5% + 5	0.5% + 5	0.5% + 5
1000 kΩ	0.1 kΩ	0.5% + 5	0.5% + 5	0.5% + 5
10 MΩ	0.001 MΩ	2.0% + 8	2.0% + 8	5.0% + 8

Accuracy for the ranges 1 R ~ 100 R is specified after subtract of the offset resistance.

CAPACITANCE

RANGE	RESOLUTION	100 Hz	120 Hz	1 kHz	10 kHz
1000 μF	0.1 μF	0.5% + 5	0.5% + 5	NA	NA
100 μF	0.01 μF	NA	0.3% + 3	0.5% + 5	NA
10 μF	0.001 μF	NA	0.2% + 3	0.2% + 3	0.5% + 5
1 μF	0.1 nF	NA	0.2% + 3	0.2% + 3	0.2% + 3
100 nF	0.01 nF	NA	0.2% + 3	0.2% + 3	0.5% + 3
10 nF	0.001 nF	NA	0.5% + 5	0.2% + 3	0.5% + 3
1000 pF	0.1 pF	NA	NA	0.5% + 5	0.5% + 3
100 pF	0.01 pF	NA	NA	0.5% + 10	0.8% + 20
10 pF	0.001 pF	NA	NA	NA	1.0% + 50

Accuracy for the ranges of 10 pF~1000 pF is specified after subtract of stray capacitances for test leads.

INDUCTANCE

RANGE	RESOLUTION	100 Hz	1 kHz	10 kHz
10 μH	0.001 μH	NA	NA	1.0% + 5
100 μH	0.01 μH	NA	1.0% + 5	0.7% + 3
1 mH	0.1 μH	0.7% + 10	0.5% + 3	0.5% + 3
10 mH	0.001 mH	0.5% + 3	0.2% + 3	0.5% + 3
100 mH	0.01 mH	0.5% + 3	0.2% + 3	NA
1 H	0.1 mH	0.2% + 3	NA	NA

ANTI-MAGNETIC/ANTI-ACID GOLD PLATED STAINLESS STEEL TIPS



ST5-IT-T
Standard replaceable tips

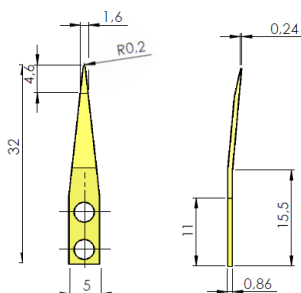

ST5-IT-TSHP
High precision sharp
replaceable tips

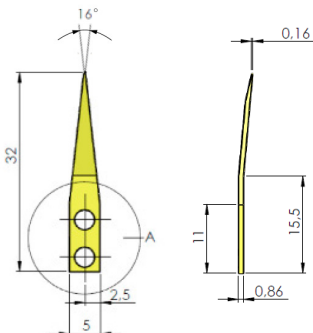

ST5-IT-TB
High precision bent
replaceable tips

